

SCHNITT A-A

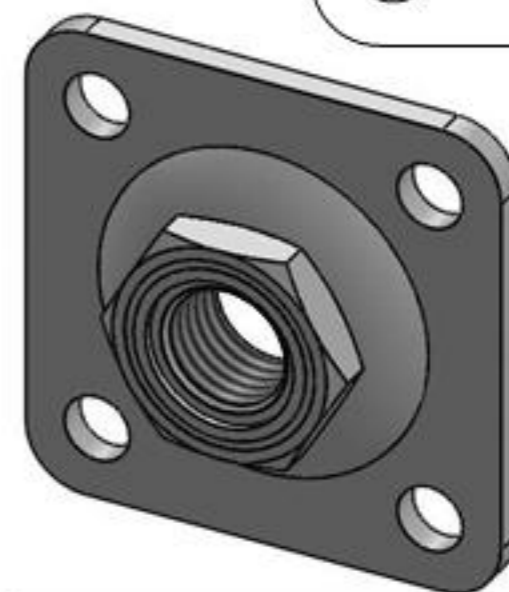

Name	Signatur	Datum	Artikelnummer	Oberfläche: Verzinkt
Ch. Häfig	CH	12.10.2022	ξ88.11860.S.M22	
Werkstoff:				Blattformat
1.0037 (S235JR)				A4
Gewicht 0.302 kg		Maßstab: 1:1.5	Version: 1	Blatt 1 von 1