

Name	Signatur	Datum	Artikelnummer	Oberfläche: Roh
Ch. Höfig	CH	17.11.2016	30.3379.8	
Werkstoff:				Blattformat
1.0037 (S235JR)				A4
Gewicht 0.793 kg		Maßstab: 1:3	Blatt 1 von 5	

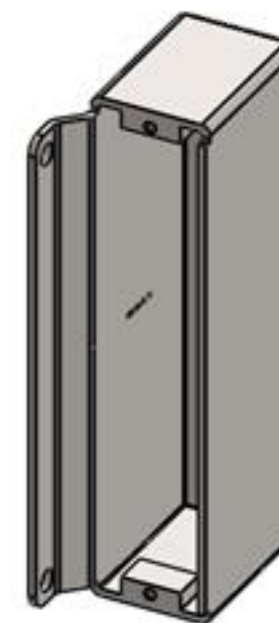

Name	Signatur	Datum	Artikelnummer	Oberfläche: Roh
Ch. Höfig	CH	17.11.2016	30.3379.81	
Werkstoff:				Blattformat
1.0037 (S235JR)				A4
Gewicht 0.686 kg		Maßstab: 1:3	Blatt 2 von 5	

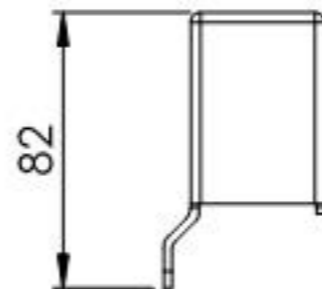
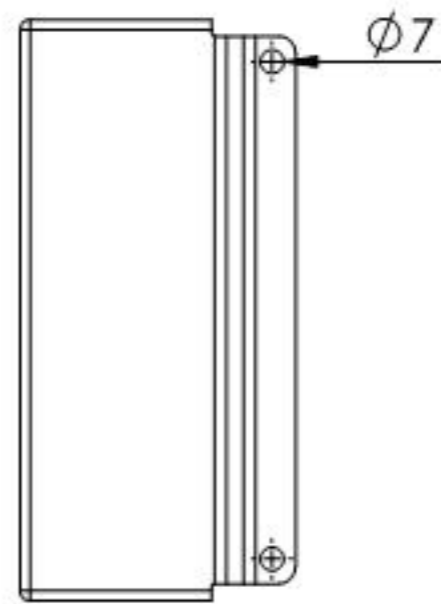
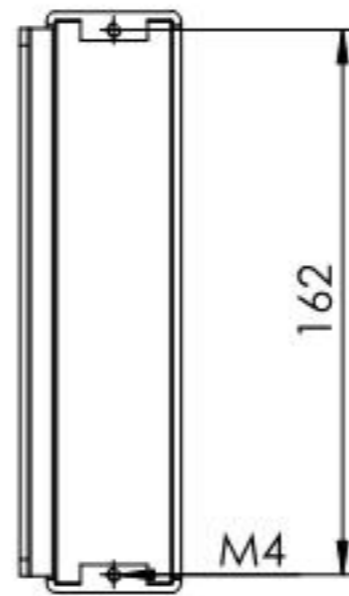
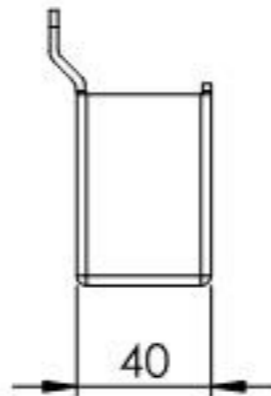
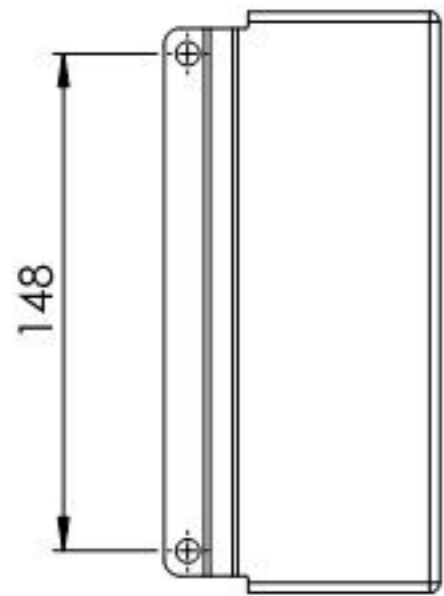
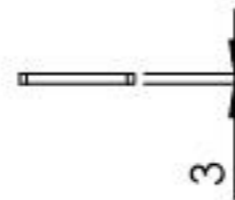
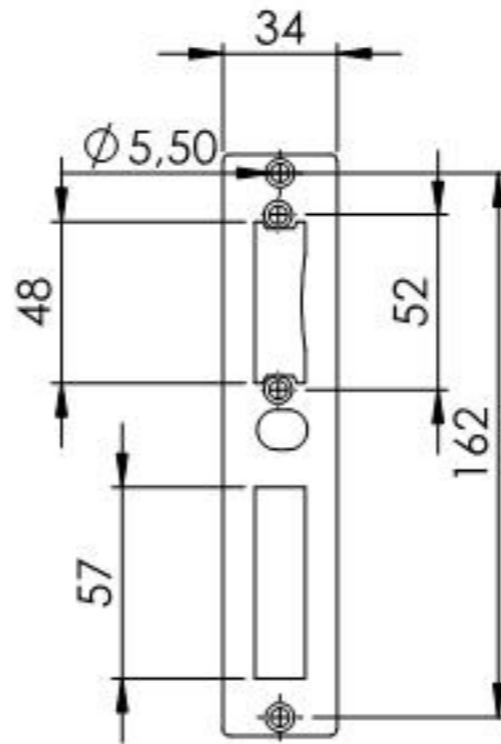
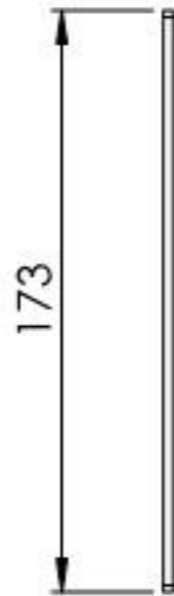

Name	Signatur	Datum	Artikelnummer	Oberfläche: Verzinkt
Ch. Höfig	CH	17.11.2016	30.3379.82	
Werkstoff:				Blattformat
1.0037 (S235JR)				A4
Gewicht 0,095 kg		Maßstab: 1:3	Blatt 3 von 5	