

SCHNITT A-A

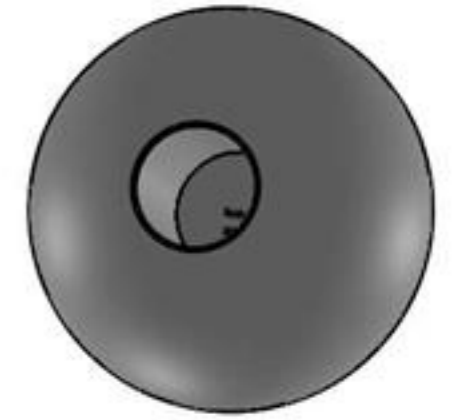
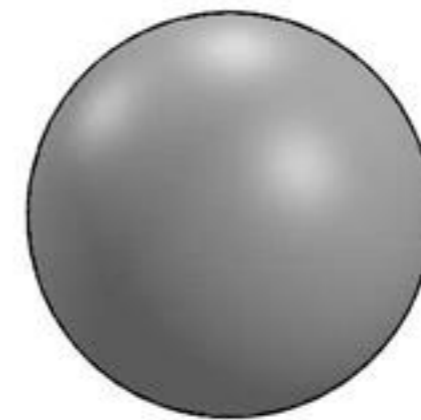
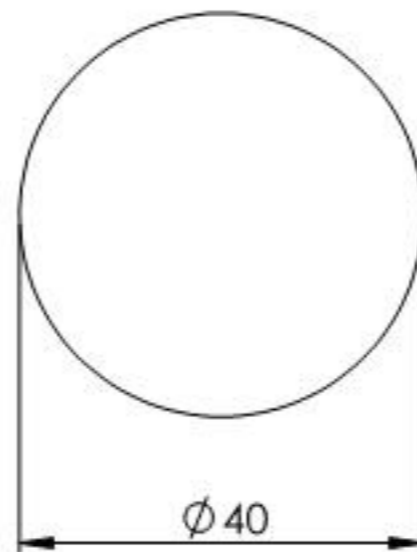
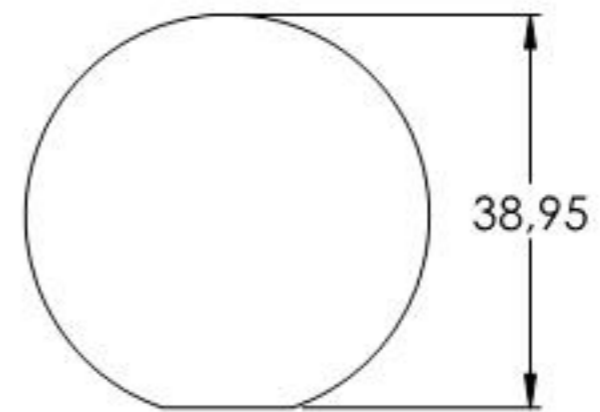
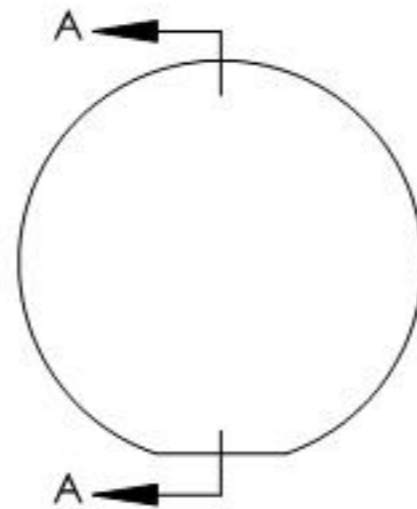
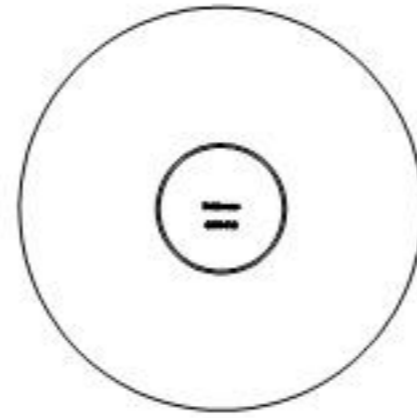
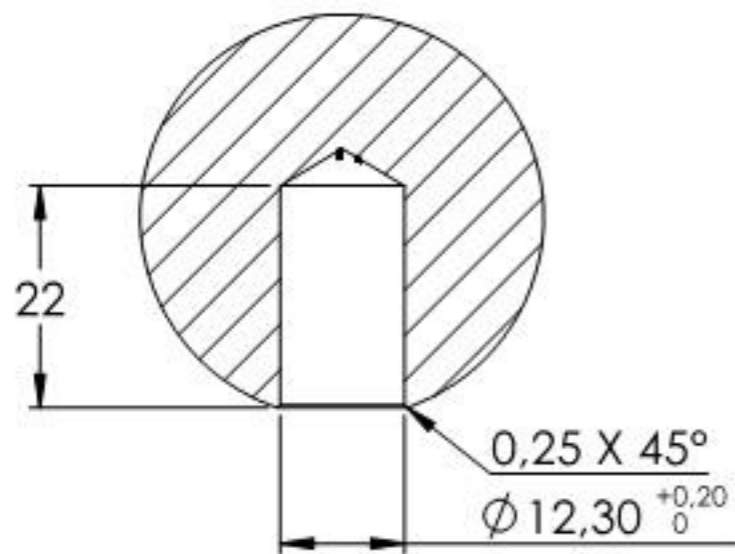

Name	Signatur	Datum	Artikelnummer	Oberfläche: Roh
Ch. Höfig	CH	03.02.2020	30.2743.8	
Werkstoff:				Blattformat
1.0037 (S235JR)				A4
Gewicht 0.239 kg		Maßstab: 1:1	Version: 1.2	Blatt 1 von 1