

Name	Signatur	Datum	Artikelnummer	Oberfläche: Geschliffen Korn 240
Ch. H5fig	CH	24.06.2022	ξ12.2156.4	
Werkstoff:				Blattformat
1.4301 (X5CrNi18-10)				A4
Gewicht 0.165 kg		Maßstab: 1:2	Version: 1	Blatt 1 von 5

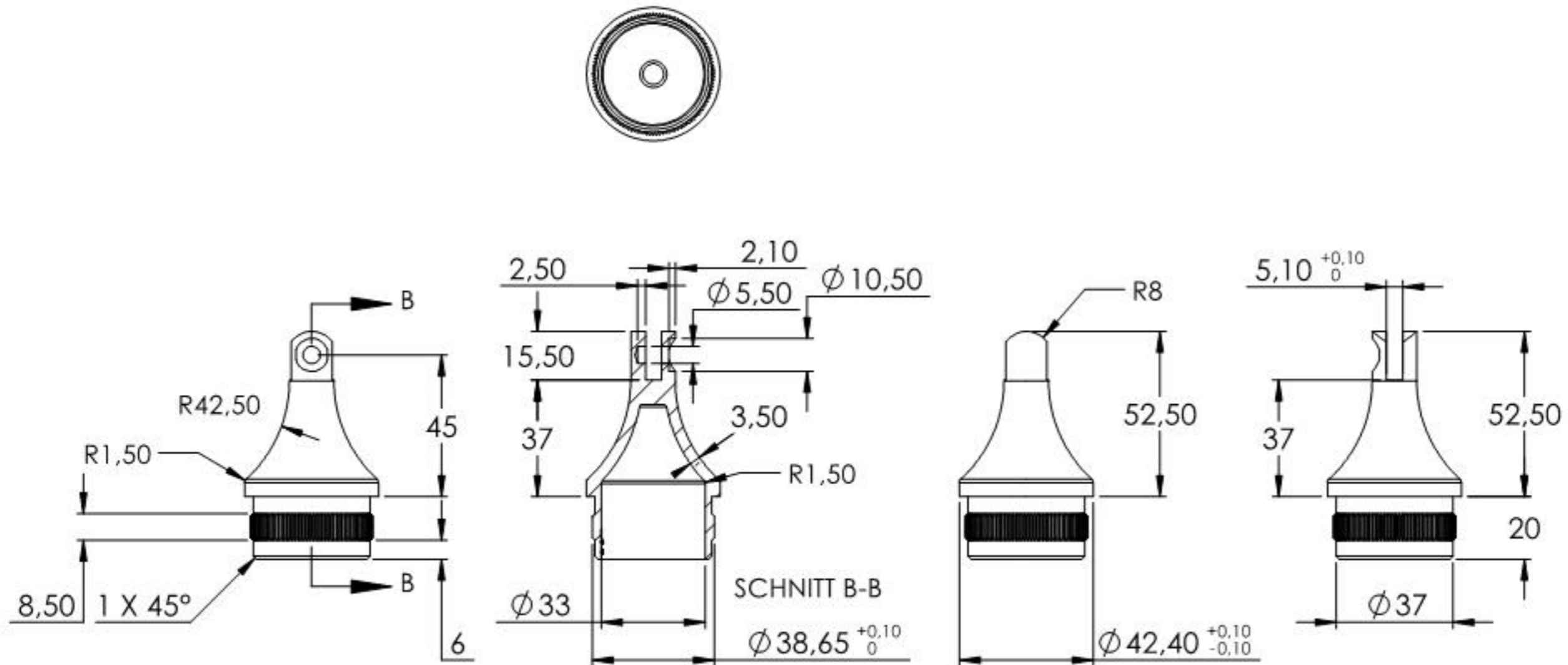

Name	Signatur	Datum	Artikelnummer	Oberfläche: Geschliffen Korn 240
Ch. H5fig	CH	24.06.2022	ξ 12.2156.4 ₁	
Werkstoff:				Blattformat
1.4301 (X5CrNi18-10)				A4
Gewicht 0.131 kg		Maßstab: 1:2	Version: 1	Blatt 2 von 5

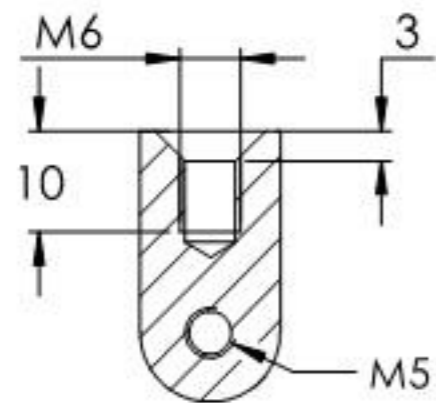

SCHNITT C-C

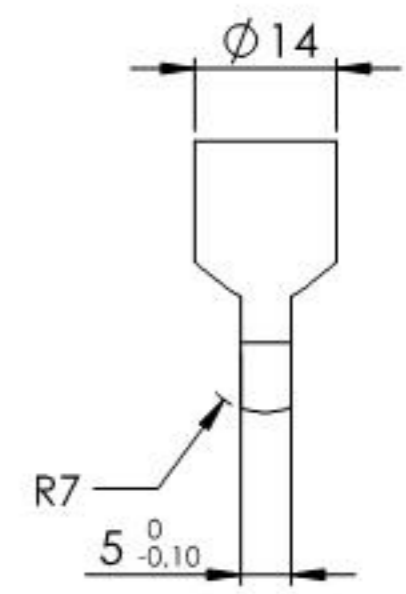
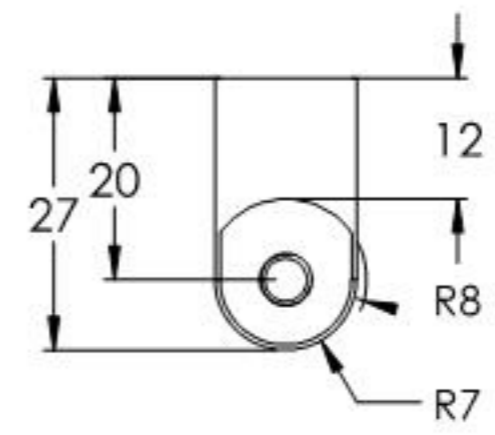
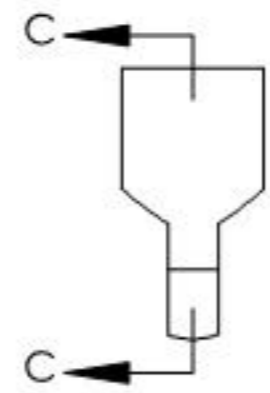
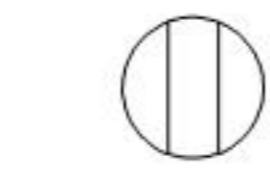

Name	Signatur	Datum	Artikelnummer	Oberfläche: Geschliffen Korn 240
Ch. H5fig	CH	24.06.2022	ξ12.2156.4 2	
Werkstoff:			Blattformat	
1.4301 (X5CrNi18-10)			A4	
Gewicht 0.019 kg		Maßstab: 1:1	Version: 1	Blatt 3 von 5