

$\phi 33,70$

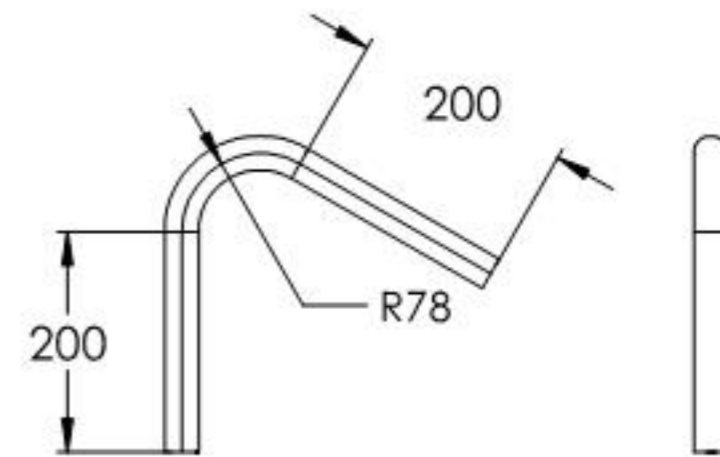

Name	Signatur	Datum	Artikelnummer	Oberfläche: ohne Nacharbeit
Ch. Hölgl	CH	07.09.2023	5 11.3777.4	
Werkstoff: 1.4301 (X5CrNi18-10)				Blattformat A4
Gewicht: 1.162 kg		Maßstab: 1:10	Version: 1	Deutsch Blatt 1 von 1